

Style
M8 Plug, shielded
5 pin
B-coding

Ratings
Voltage: 30V
Current: 3A

Operating Temperature Range
-40~105 °C

Materials
① Insulator: PA66, UL 94 HB, black
② Pin: C3604 brass, gold flashing
③ Nut: C3604 brass, nickel plated
④ Shell: C3604 brass, nickel plated
⑤ O-ring: Nitrile rubber, black

Electrical Requirements
Dielectric strength: 1 min @ 500 Vac
Insulation resistance: 100 MΩ @ 500 Vdc
Contact resistance: 10 mΩ or less

Mechanical Requirements
Life cycle: 1000 mating cycles minimum

Environmental Requirements
Salt spray test: 35 °C, relative humidity 90-95%, 5% NaCl mist for 24 hrs. Wash parts after test. Maintain mechanical requirements and a contact resistance of less than 10 mΩ.
Waterproof: IP67

Assembly Info
Wire gauge: 24 AWG max

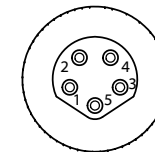
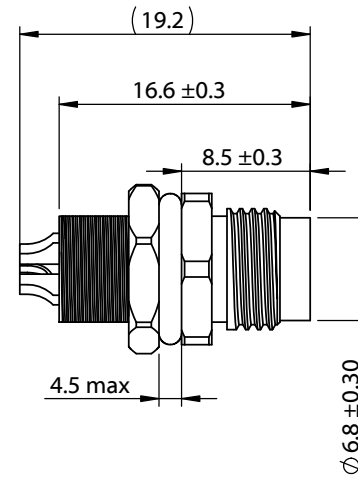

Front View
Not to Scale

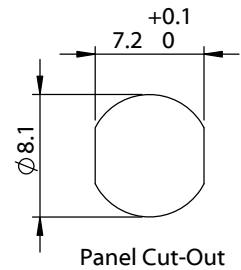
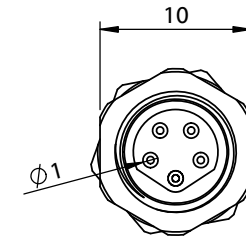
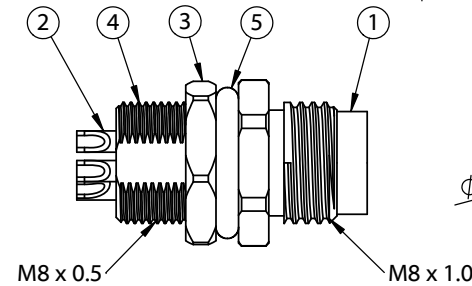
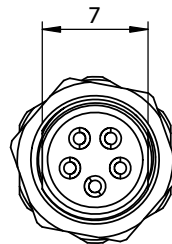

Revision:	Date:	Description:	Prepared:	Notes:	<h1>TENSILITY</h1> tel 1.541.323.3228 800 877.670.7118 fax 1.541.323.4202 web tensility.com
A	1/19/2023	Initial Release	Verified:	RoHS compliant Function test: no open, no short circuit, no intermittent	
			Dimensions are in millimeters. Tolerances: X: ± 0.3 mm X.X: ± 0.1 mm X.XX: ± 0.05 mm	Description: Connector, 5 pin M8 B-code plug, 8x19.2 mm, gold plated, panel mount, solder cup, IP67	Size: A Part number: 54-00318
					Scale: 2:1  Sheet 1 of 1