

**Ratings**

Voltage: 300V  
 Temperature  
 Static: -40~105 °C  
 Dynamic: -20 to 105 °C  
 Flammability: VW-1  
 Water resistant: 75 °C  
 Oil resistant: 60 °C (jacket)  
 ≥50% elongation and tensile strength after aging  
 UV resistance: jacket, 720 hours xenon or carbon arc exposure  
 ≥80% tensile strength and elongation after aging

**Conductor**

Conductor count: 5  
 Gauge: 24 AWG 0.21 mm<sup>2</sup>  
 Material: tinned copper strands  
 Strand size: Ø 0.08 mm x 41  
 Resistance at 20 °C: 94.2 Ω /km Max

**Insulator**

Material: PVC  
 Color: red, black, white, yellow, blue  
 Diameter: Ø 1.4 ±0.10 mm  
 Nominal thickness: 0.38 mm  
 Resistance at 20 °C: 10 MΩ /km Min

**Wrap**

Material: cotton paper

**Filler**

Material: cotton rope

**Outer jacket**

Material: PVC, 80A  
 Color: Black  
 Diameter: Ø 5.6 ±0.25 mm  
 Nominal thickness: 0.80 mm

**Wire marking:** E339579 UL AWM STYLE 20387 24 AWG 105°C  
 300V VW-1 60°C OIL RESISTANT UV RESISTANT TENSILITY

**Use:** External wiring

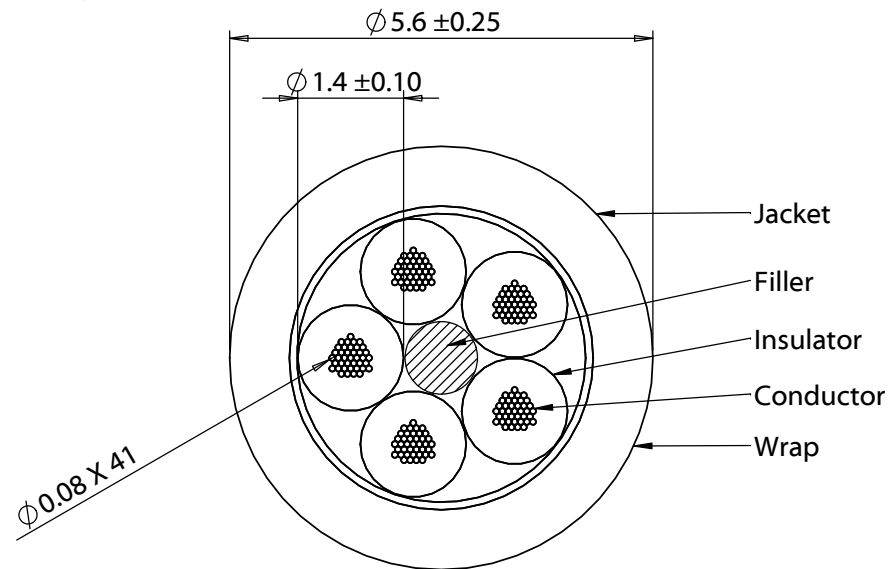
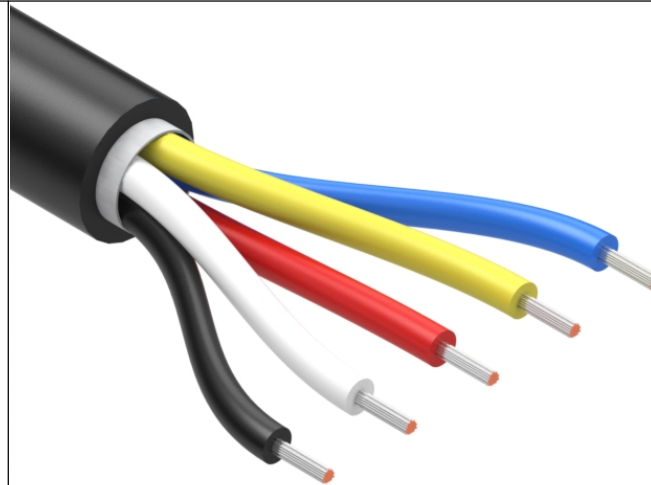

Revision:	Date:	Description:	Prepared:	Notes:	<b>TENSILITY</b> tel 1.541.323.3228 800 877.670.7118 fax 1.541.323.4202 web tensility.com
A	10/04/2020	Initial release	Verified:	RoHS compliant Function test: no open, no short circuit, no intermittent	
			Dimensions are in millimeters. Tolerances: X: ± 0.5 mm X.X: ± 0.3 mm X.XX: ± 0.05 mm	Description: Wire, 5C TS, 24 AWG, UL20387, 300V, 105C, 60C oil, UV, 5.6 mm, VW-1, PVC, 80A, black	Size: A Part number: 30-01667
					Scale: 10:1  Sheet 1 of 1

5

4

3

2

1