

ITEM NO.	PART NUMBER	DESCRIPTION	QTY.	COMPONENT NOTES
1	50-01003	Connector, 5 pin M8 B-code plug, 8x19.2 mm, gold plated, molding style, solder cup, IP67	1	
2	30-02980	Wire, 5C TS, 24 AWG, UL20387, 300V, 105C, 60C oil, UV, 5.6 mm, VW-1, PVC, 80A, black	1	
3	24-00400	Overmold, M8 plug and jack, 180°	1	PVC, black

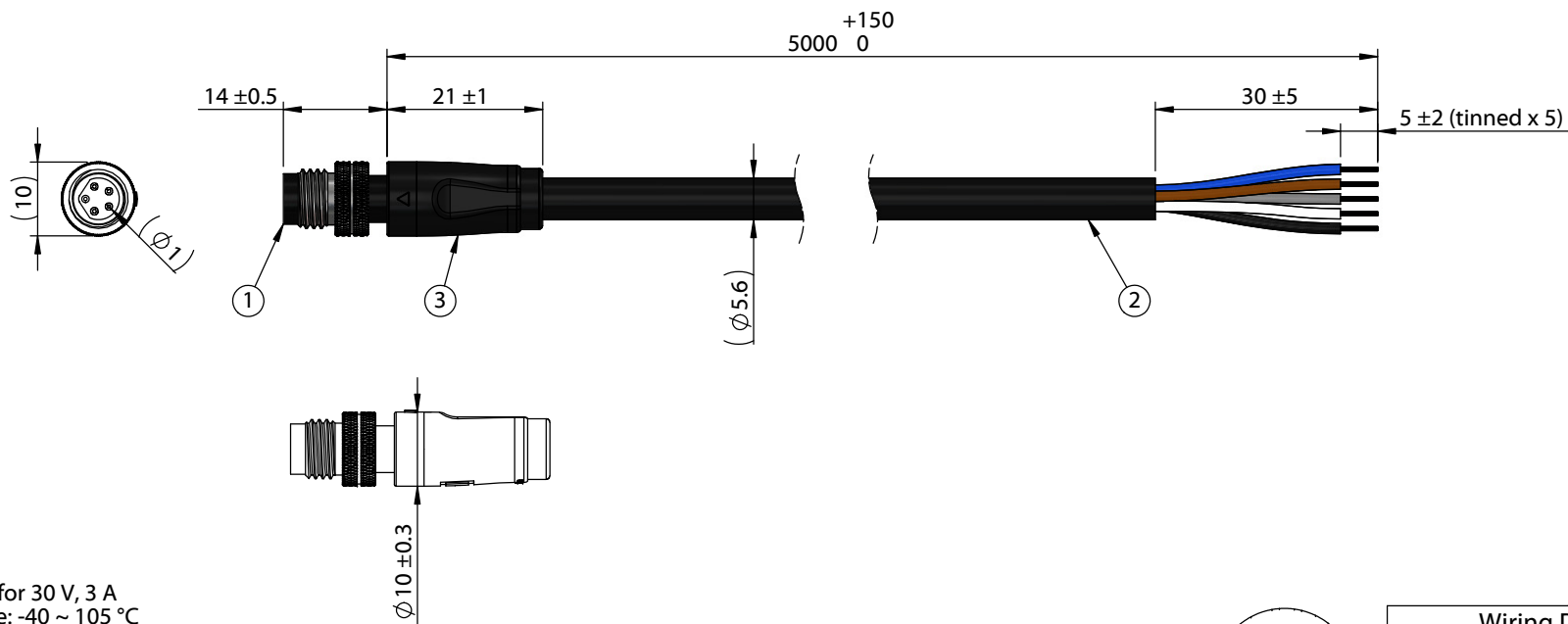

**Notes:**  
 Cable rated for 30 V, 3 A  
 Temperature: -40 ~ 105 °C  
 Oil resistant up to 60 °C  
 Water resistant up to 75 °C  
 UV resistant

IP67 waterproof rating when mated with corresponding (IP67) connector

Functionally equivalent components may be substituted

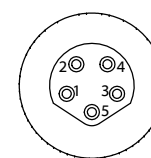

Front View  
Not to Scale

Wiring Diagram	
50-01003	wire color
1	brown
2	white
3	blue
4	black
5	gray

Revision:	Date:	Description:	Prepared:	Notes: RoHS compliant Function test: no open, no short circuit, no intermittent	<h1>TENSILITY</h1> <p>tel 1.541.323.3228 800 877.670.7118          fax 1.541.323.4202 web tensility.com</p>
A	3/13/2023	Initial release	Verified:		
			Dimensions are in millimeters. Tolerances: X: ± 0.5 mm X.X: ± 0.3 mm X.XX: ± 0.05 mm	Description: Cable, 5000mm, 1.0 mm 5C 50-01003 M8 plug to 5mm tinned, 24 AWG, 30-02980 wire	Size: A
					Part number: 10-05347
					Scale: 1:1
					Sheet 1 of 1

5

4

3

2

1